

680A/680P/680AEx/680PEx/601Ex
Digital Pressure Gauge



Additel 680A/680P/680AEx/680PEx/601Ex

Digital Pressure Gauge

-----User Manual

[Version: 2405V01]

Additel Corporation

STATEMENT

This user manual provides operating and safety instructions for Additel Digital Pressure Gauges. To ensure correct operation and safety, please follow the instructions in this manual. Additel Corporation reserves the right to change the contents and other information contained in this manual without notice.

Content

1.Introduction	2
1.1 General Introduction	2
1.2 Technical Specifications	3
1.3 Features.....	5
1.4 Basic Structure	6
1.5 Power Supply.....	9
1.6 Battery Life and Configuration	10
2.Display and Operation	12
2.1 Main Display	12
2.2 Main Operation Interface	13
2.3 Buttons.....	14
2.4 Pressure Measurement.....	15
2.4.1 Pressure Percentage Indication.....	15
2.4.2 Pressure Zeroing.....	15
2.4.3 Pressure Unit Switching	15
2.4.4 Pressure Tare	16
2.5 Pressure Peak Value	16
2.6 Screen Lock and Unlock.....	17
2.7 Password Keyboard Display and Editing	18
2.8 Numeric Keyboard Displays and Editing.....	19

2.9 Cycle Selection Keyboard Display and Editing	19
3.System Settings	21
3.1 Data Log Settings	21
3.1.1 Start/stop Data Log.....	21
3.1.2 Occupied Storage Capacity.....	22
3.1.3 Interval Setting.....	22
3.1.4 Clear Data	22
3.2 Configuration	22
3.2.1 Pressure Sampling Rate.....	23
3.2.2 Resolution	23
3.2.3 Auto-backlight Time Settings	23
3.2.4 Auto Oower Off Settings	23
3.2.5 Filter	24
3.2.6 Tare Settings.....	24
3.2.7 Temperature Unit Settings	25
3.3 Custom Unit Settings	25
3.4 Date and Time Settings.....	25
3.5 Pressure Calibration	25
3.5.1 Calibration Settings	25
3.5.2 Calibration Process	25
3.6 System Settings.....	30
3.6.1 Restore to Factory Settings	30

3.6.2 Version Information.....	30
3.6.3 Over Pressure Records	30
3.6.4 Pressure Module Version Information.....	31
3.7 Communication Settings.....	31
3.7.1 Bluetooth MAC Address	31
3.7.2 Bluetooth Auto-off Settings	31
3.7.3 Serial Settings	31
3.8 Operation Error Codes.....	31
4.Connect to Additel Link app.....	33
4.1 Download Additel Link.....	33
4.2 Enable the Bluetooth.....	33
4.3 Connect to the Gauge.....	33
4.3.1 Scan the Code.....	33
4.3.2 Manual Connection by Searching MAC Address	34
5.Copyright	35
Appendix A: RS232 Module DB9 Pins Description	36
Appendix B: Special Notice for ADT680AEx/680PEX/601Ex Serial Connection	38
Appendix C: ADT680AEx/680PEX/601Ex EX-Proof Description	39

Figure Content

Figure 1 Basic Structure of ADT680A/680AEx/601Ex	6
Figure 2 Basic Structure of ADT680P/680PEx	7
Figure 3 Install batteries	9
Figure 4 Power supply by adapter	9
Figure 5 Main Display	13
Figure 6 Main Operation Interface	14
Figure 7 Pressure percentage indication	15
Figure 8 Maximum pressure value	16
Figure 9 Minimum pressure value	17
Figure 10 Password display and editing	18
Figure 11 Numeric keyboard	19
Figure 12 Cycle selection keyboard	20
Figure 13 Data log display	22
Figure 14 Lower limit calibration point	26

Figure 15 Lower limit calibration.....	27
Figure 16 Upper limit calibration point.....	28
Figure 17 Upper limit calibration.....	29
Figure 18 Calibration status menu	30
Figure 19 QR code for downloading Additel Link	33
Figure 20 Scan code for connection.....	34
Figure 21 Manual search for connection	34
Figure 22 RS232 module DB9 female pins description	36

Safety Instructions

Warning: The situation that poses a threat to user safety.

Attention: The condition that may cause damage to the gauges or affect the calibration result.

Warning:

To prevent the user from injury, please follow this user manual for use.

To prevent fire, electric shock, or personal injury, please do as follows:

1. General:

The pressure medium should be confirmed before use. Please adhere to the following instructions:

- ◆ Please read the user manual before using the product;
- ◆ Before using the product, please check the appearance of the product to ensure there is no damage;
- ◆ Please refer to the operation steps in the manual when using the product;
- ◆ Please be sure to store, transport and use this product in the correct direction;
- ◆ If the product is damaged or malfunctions, please do not use it and contact Additel;
- ◆ Never use the non-Ex version in an explosive, steam, or dusty environments.

2. Electrical:

- ◆ Before using the product, please make sure that the power supply is connected correctly.

Attention:

To prevent injury, please obey the instruction manual for use

To prevent possible damage, please do as follows:

- ◆ Do not use the instrument in a high vibration environment;
- ◆ If the gauge is abnormal, please stop using it and contact Additel.

1. Introduction

1.1 General Introduction

ADT680A/680P/680AEx/680PEx/601Ex Digital Pressure Gauge series is the latest generation digital pressure gauges introduced by Additel Corporation. It is mainly used to calibrate precision pressure gauges, general pressure gauges, sphygmomanometers or other pressure instruments and it can also be widely used for precision pressure measurement.

The power consumption of ADT680A/680P/680AEx/680PEx/601Ex is extremely low, which is suitable for long-term continuous work. It also has excellent electromagnetic compatibility characteristics and obtained the CE certification and can be used in various complex electromagnetic environments.

Contact us:

Additel Corporation

Tel: +1-714-998-6899

www.additel.com

1.2 Technical Specifications

Table 1 Technical Specifications

Item	ADT680A	ADT680AEx	ADT680P	ADT680PEx	ADT601Ex
Ex-proof level	None	Ex ia IIC T4 Ga	None	Ex ia IIC T4 Ga	Ex ia IIC T4 Ga
Protection Level	IP67				
Case Material	SS				
Dimensions	148mm*105mm*48mm		φ140mm*119mm		142mm*92mm*43mm
Weight	620g		730g		525g
Display	FSTN segment LCD				
Button	3 Function buttons, 1 Power ON/OFF button				
Storage	800,000 records (Time+Pressure)				None
Wireless communication	BLE				
Communication module	RS232		RS232		None



Installation	Radial		Axial		Radial
Power	3*AA batteries, external power DC9V (via RS232) typical power consumption 3.5mW	3*AA approved batteries, typical power consumption 3.5mW (Table 3)	3*AA batteries, external power DC9V (via RS232) typical power consumption 3.5mW	3*AA approved batteries, typical power consumption 3.5mW (Table 3)	
Environmental	1. Storage Temperature: (-40 ~ 75)°C				
	2. Operating Temperature: (-20 ~ 50)°C				
	3. Humidity: (10~95)%RH, non-condensing				
Pressure range and accuracy	Please refer to Additel website				
Functional features	Peak value, filter, tare, pressure unit switch, data logging.				

1.3 Features

- ◆ Ultra-low power consumption design, long-term operation;
- ◆ Wide pressure ranges (100kPa~4200 bar);
- ◆ Data logging up to 800,000 records (Time+Pressure)

1.4 Basic Structure

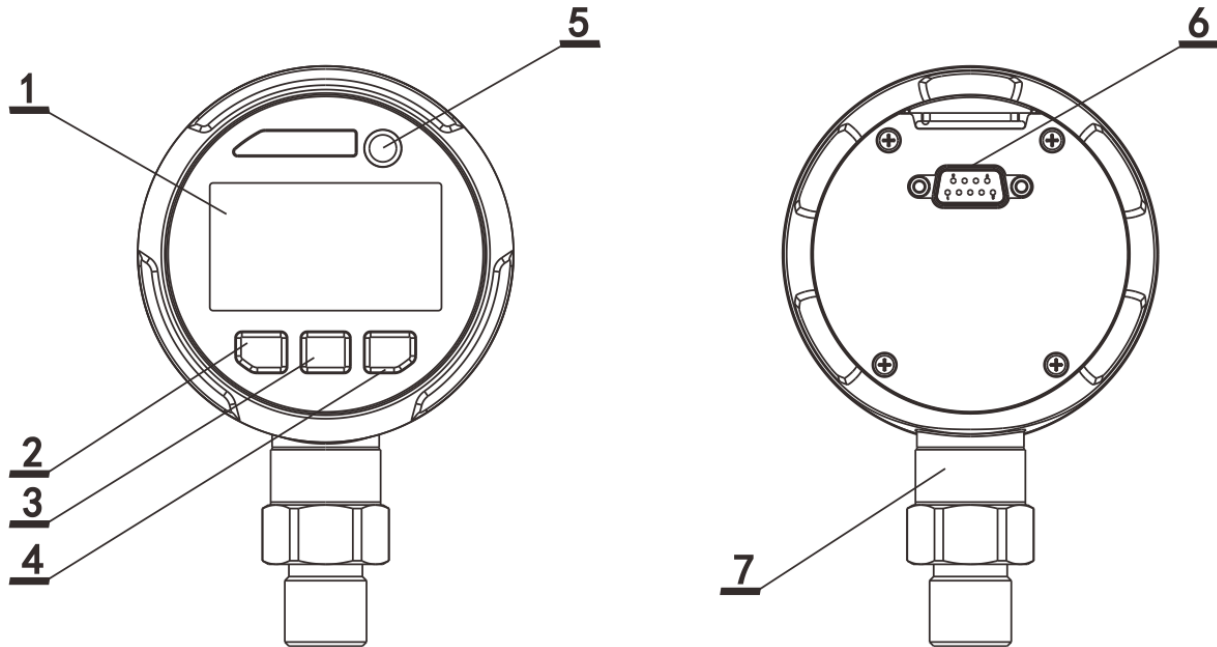

Figure 1 Basic Structure of ADT680A/680AEx/601Ex

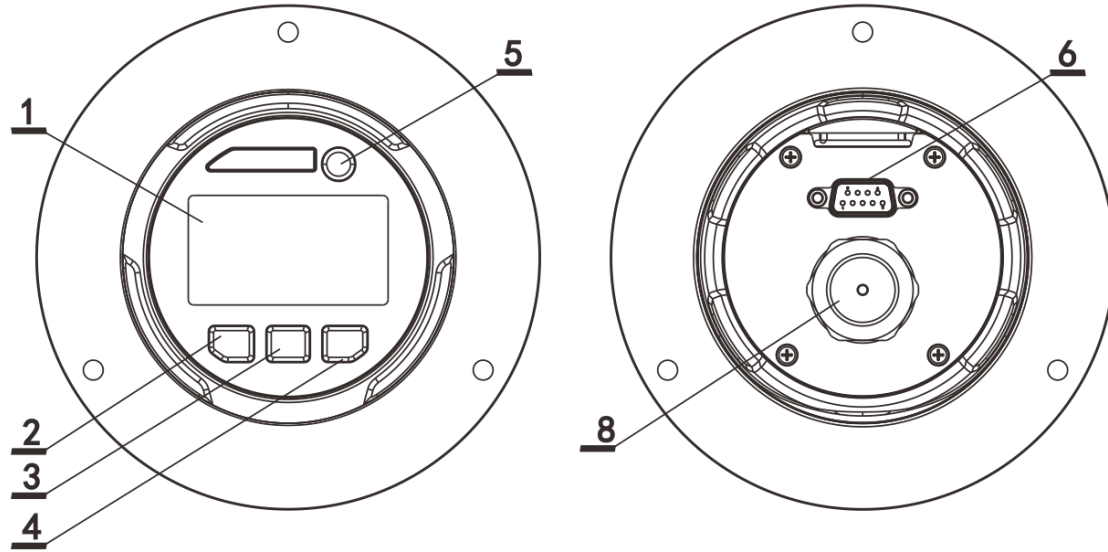





Figure 2 Basic Structure of ADT680P/680PEX

Table 2 Basic Structure

No.	Part Name	Icon	Description
1	Display	/	Show pressure, menu.....
2	Unit button		Short press: switch units in main display, move to right, "return"
			Long press: go to Settings in main display
3	Backlight button		Short press: in main display, backlight on/off; other menus, move downward
			Long press: view peak values in main display
4	Zero button		Short press: pressure zero in main display, or "Confirm"
			Long press: Bluetooth on/off in main display
5	Power button		Short press: Unlock, functions as "return" when in number input or menus.
			Long press: to power on/off
6	Communication module	/	RS232 or empty
7	Pressure sensor	/	Integrated with the gauge
8	Pressure module	/	Digital pressure module, removable

1.5 Power Supply

For ADT680A/680P, Power can be supplied by battery or 9814 RS232 power supply communication kit (Optional).

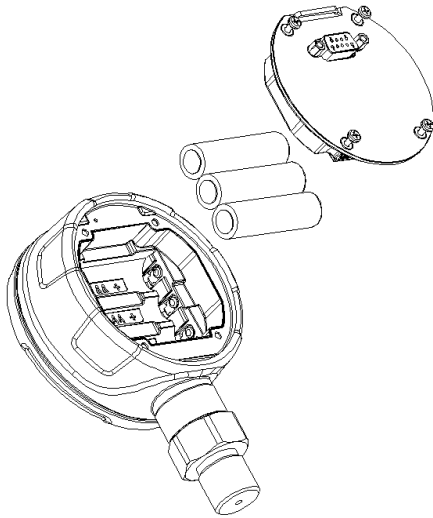

Figure 3 Install batteries

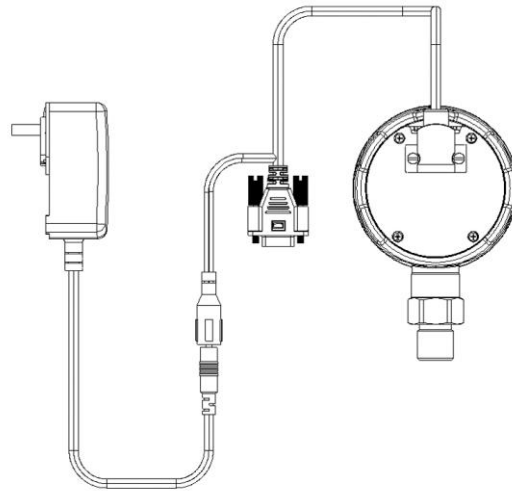

Figure 4 Power supply by adapter

For ADT680AEx/680PEx/601Ex, power is supplied by battery.

Table 3 Approved battery models

Manufacturer	Type	Ta
ENERGIZER	E91	(-18~45)°C
Maxell	LR6	(-20~60)°C
Rayovac	815	(-30~55)°C

Warning:

- ◆ If using battery, please replace battery when the device is automatically powered off due to low power.
- ◆ When replacing the battery, please note the direction of battery electrodes.
- ◆ Never replace the battery in hazardous area.
- ◆ Use only the approved battery models.

1.6 Battery Life and Configuration

Table 4 Battery life and configuration

System mode	Pressure display rate	Battery life
Normal	10 readings/ 1 s	1,000 h

Low power consumption	3 readings/ 1 s(L)	4,000 h
Low power consumption	2 readings/ 1 s (L)	5,000 h
Low power consumption	1 reading/ 1 s (L)	9,000 h
Low power consumption	1 reading/ 2 s (L)	10,000 h
Low power consumption	1 reading/ 3 s (L)	11,000 h
Low power consumption	1 reading/ 4 s (L)	12,000 h
Low power consumption	1 reading/ 5 s (L)	13,000 h
Low power consumption	1 reading/ 6 s (L)	14,000 h
Low power consumption	1 reading/ 7 s (L)	15,000 h
Low power consumption	1 reading/ 8 s (L)	16,000 h
Low power consumption	1 reading/ 9 s (L)	17,000 h
Low power consumption	1 reading/ 10 s (L)	18,000 h

Note:

[1] The “L” in the table indicates the pressure module is in low power consumption mode. By going to secondary menu, users can set the pressure display rate, refer to Para.3.2.1 for detail. For ADT680A/680AEx/680P/680PEX, the default setting is 3 readings/ 1 s in low power consumption mode. For ADT601Ex, the default setting is 1 reading/ 1 s in low power consumption mode.

2. Display and Operation

2.1 Main Display

Main display as shown in Figure 5:

- ◆ Status bar: Including battery, wireless, Bluetooth, REC, button lock, filter, ABS, Min, Max, and tare icon. When the battery power is too low, it will prompt the low battery to automatically turn off and will start to countdown to turn off the gauge automatically.
- ◆ Unit area :Including kPa, Pa, mbar, bar, MPa, mmHg, inHg, psi, mmH₂O, inH₂O, kgf/cm², varies by pressure ranges, “U” means custom unit. Temperature units include °C and °F.
- ◆ Data display area: Display pressure values and edit items;
- ◆ Percentage pressure indicating area: Displays the pressure percentage.

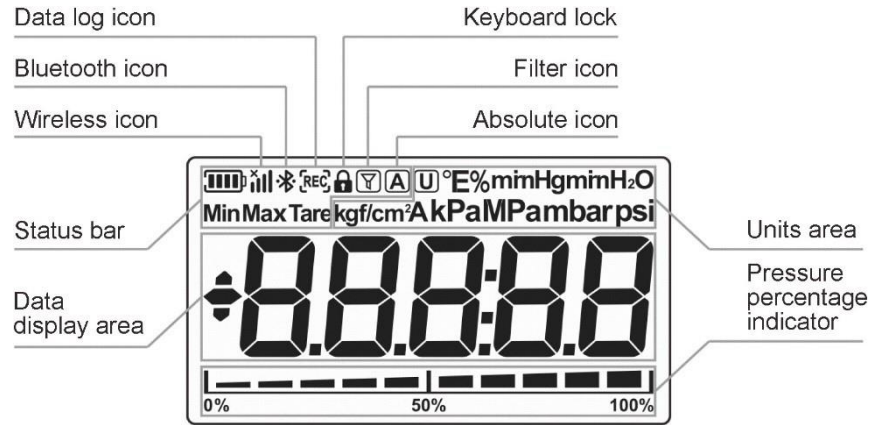

Figure 5 Main Display

2.2 Main Operation Interface

After the pressure gauge is turned on, it first displays the interface of the original range of the pressure module. 3 seconds later, it will enter the main display immediately. The main display is divided into: status bar, pressure unit area, pressure value area and pressure percentage display area, as shown in Figure 6.

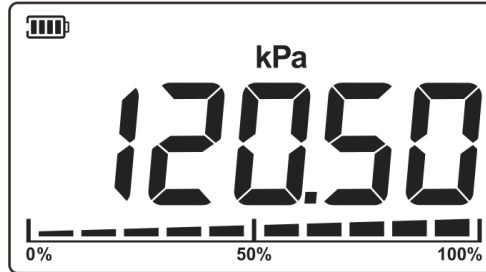

Figure 6 Main Operation Interface

1. Status Bar: Including battery, filter status, absolute pressure, Bluetooth, data log and button lock;
2. Unit: Pressure unit, press Unit button to switch;
3. Data display area: Display pressure values ;

2.3 Buttons



Power button: Short press to unlock the buttons. Long press to power on/off the gauge;



Unit button: Short press: switch units in main display, move to right, "return." Long press: go to Settings in main display;



Backlight button: Short press: backlight on/off in main display or move downward. Long press: view peak values in main display;



Zero button: Short press: pressure zero in main display, or “Confirm.” Long press: Bluetooth on/off in main display.

2.4 Pressure Measurement

When the gauge is in the main display, it will show the current pressure unit and real-time pressure value in unit area and display area. And it will show the pressure percentage at the bottom of the display.

2.4.1 Pressure Percentage Indication

The pressure gauge displays the pressure percentage at the bottom of the display after entering the main display. As shown in Figure 7, it has ten grids.

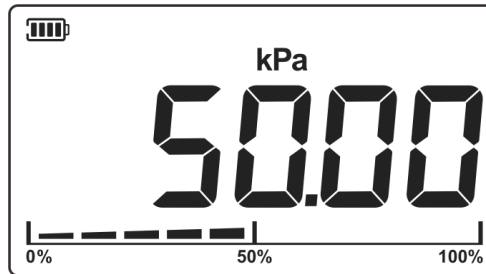

Figure 7 Pressure percentage indication

2.4.2 Pressure Zeroing

Press Zero button to zero pressure.

2.4.3 Pressure Unit Switching

Press the Unit button to switch the pressure units. The pressure units vary from different pressure ranges, not all units can be selected depending on the gauge model.

2.4.4 Pressure Tare

When tare is enabled in the secondary menu, the current pressure value will be assigned to the tare value. At this moment, tare takes effect, and the tare icon will be flashing. Return to the main display and short press the Zero button to disable the tare function. At this moment, the tare icon will no longer flash. When pressing Zero button again, the tare function will take effect. If you need to disable the tare function, you need to disable it in the secondary menu.

2.5 Pressure Peak Value

The device automatically records the maximum and minimum pressure values that occur during the pressure measurement. The recorded peak value can be viewed in the pressure peak function by long pressing the Peak button on the main display. The maximum pressure value is displayed in Figure 8, short press Peak again to view the minimum pressure value, as shown in Figure 9. And finally, short press the Peak button to return to the main display. In the process of viewing the peak value, short press the Zero button to clear the peak value.



Figure 8 Maximum pressure value



Figure 9 Minimum pressure value

Table 5 Pressure peaks setting

Subject	Introductions
Max	Maximum Value
Min	Minimum Value
Zero	Reset data

2.6 Screen Lock and Unlock

Short press the Power button to lock and unlock the screen. When the screen is locked, a lock icon will be displayed in the status bar. Click other places on the screen, the lock icon will flash to remind the pressure gauge has entered the lock screen status.

Note: If password protection is enabled, you will be prompted to enter the password to unlock, and only the correct password can unlock the display.

2.7 Password Keyboard Display and Editing

The password keyboard will pop up when performing pressure gauge calibration, restore to factory setting and clear the data log. The password keyboard can edit each digit. The digit being edited will flash, short press the Down button to switch numbers, and short press Right button to move to next digit. Short press Enter button to confirm the password. Short press Power button to go to previous menu. As shown in Figure 10.

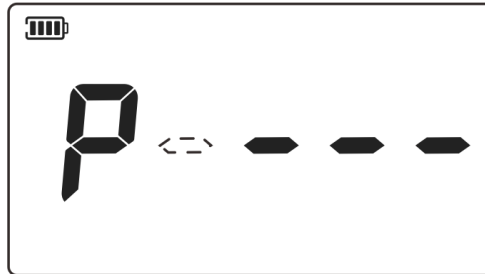

Figure 10 Password display and editing

2.8 Numeric Keyboard Displays and Editing

The pressure gauge provides a numeric keyboard, as shown in Figure 11. Adjust the value for each digit, digit being edited will flash, short press Down button to switch numbers, and short press Right button to move to next digit. Short press Enter button to confirm. Short press Power button to go to previous menu.



Figure 11 Numeric keyboard

2.9 Cycle Selection Keyboard Display and Editing

The system provides a cycle selection keyboard to set parameters, as shown in Figure 12. The main display area will flash to indicate that it is being edited, for example the baud rate is now set to 9600, and the baud rate can be switched by pressing the Down buttons. Short press Enter button to save the setting and exit, short press Power button to go to previous menu.



Figure 12 Cycle selection keyboard

3. System Settings

In the main display, long press the Settings button to enter the system setting, and short press the Settings button in the setting interface to return. In the system settings, short press the Down button to cycle through the various menus. If a menu contains submenus, short press the Enter button to switch each submenu.

The system settings include the following:

- ◆ Data log settings;
- ◆ Configuration menu;
- ◆ Custom units;
- ◆ Time and date;
- ◆ Calibration;
- ◆ System;
- ◆ Communication.

3.1 Data Log Settings

The display area shows 1.REC. It Includes: Start/stop data log, occupied storage capacity, logging interval and clear data. Short press Enter button to enter the menu. (available only for ADT680A/680AEx/680P/680PEx)

3.1.1 Start/stop Data Log

Enter the menu, the display area shows 1.OFF or 1.ON to indicate the data log status. Short press the Enter button to open or close the data log. When data log is started, the icon  in the status bar flashes every once in a while, indicating that data log is in progress. If you return to the main display after starting the data log session, the screen will be locked directly, or if you do not operate the button for 1 minute, it will automatically return to the main display and lock the screen.

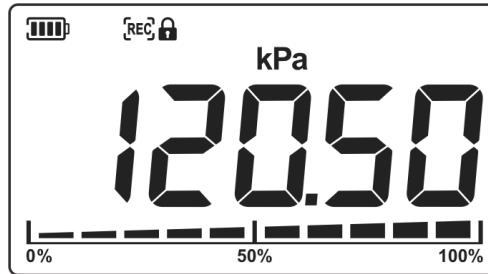

Figure 13 Data log display

3.1.2 Occupied Storage Capacity

The title bar displays 2.CAP, short press Enter button to view the occupied storage capacity.

3.1.3 Interval Setting

The title bar displays 3.GAP, short press Enter button to edit the logging interval, range is from 1 s to 99999 s, or 0.1 s. When editing, short press the Power button to give up and return to previous menu, short press Enter button to save and return to previous menu.

3.1.4 Clear Data

The title bar displays 4.dEL, short press Enter button to input password 1234, then short press Enter to clear all recorded data.

3.2 Configuration

The display area shows 2.CONF. It Includes: pressure sampling rate, resolution, backlight, auto power off, filter, tare, and temperature units. Short press Down button to cycle among the sub menus.

3.2.1 Pressure Sampling Rate

The display area displays 1.RATE, short press the Enter button to enter the pressure sampling rate setting. 3-1L means that the pressure module takes 3 samples per second. For ADT680A/680AEx/680P/680PEX, the default setting is 3 times per second in low power mode. For ADT601Ex, the default setting is 1 time per second in low power mode.

The pressure gauge provides the following sampling rate settings:

10—1(10 readings /1 sec) 3—1L(3 readings /1 sec) 2—1 L(2 readings /1 sec) 1—1 L(1 reading /1 sec)
1—2 L(1 reading /2 sec) 1—3 L(1 reading /3 sec) 1—4 L(1 reading /4 sec) 1—5 L(1 reading /5 sec) 1—6 L(1 reading /6 sec) 1—7 L(1 reading /7 sec) 1—8 L(1 reading /8 sec) 1—9 L(1 reading /9 sec) 1—10 L(1 reading /10 sec)

“a L” indicates that the gauge is in low power consumption mode, and without the “L” it indicates that the gauge is in normal working mode.

3.2.2 Resolution

The display area displays 2.bit, short press Enter button to edit the resolution. It supports 4 digits and 5 digits. (available only for ADT680A/680AEx/680P/680PEX)

3.2.3 Auto-backlight Time Settings

The display area displays 3.LED, short press Enter button to edit the auto-backlight turn off time. It supports 15 seconds, 30 seconds, 45 seconds, 60 seconds, and ON (the backlight is always on).

3.2.4 Auto Power Off Settings

The display area displays 4.AOFF, short press Enter button to enter the auto power off setting. It supports OFF (auto power off function is disabled), 15 minutes, 30 minutes, 45 minutes, 60 minutes, 90 minutes, and 120 minutes.

3.2.5 Filter

The display area displays 5.FILT, short press Enter button to enter the filter mode settings. OFF means to turn off the filter, 1Ord means to select the first-order filter mode, and 3~10 mean the average filter. (available only for ADT680A/680AEx/680P/680PEX)

Table 6 Filter settings

Subject	Effective values	Description
First-order coefficient	0.05~1	Available for first-order filtering mode, default is 0.05, can be changed by commands
Number of filtered samples	3~10	Number of samples for average filtering
Extreme value pairs will be removed	0~4 (The Extreme value pairs number should not exceed (Samples number-1)/2)	Extreme value pairs will be removed in average filtering, default is 0, can be changed by commands

3.2.6 Tare Settings

The display area displays 6.TARE, short press Enter button to enter the Tare settings. After Tare is enabled, the Tare icon will flash to indicate Tare takes effect. Otherwise, the Tare icon will only appear but not flash. After Tare is enabled, short press the Zero button in main display to switch the Tare status. When the Zero button is pressed, the current pressure value will be captured once as the Tare value. Press the Zero button again and Tare will no longer take effect. (available only for ADT680A/680AEx/680P/680PEX)

3.2.7 Temperature Unit Settings

The display area displays 7.TEMP, short press the Enter button to enter the temperature unit settings. It supports Celsius and Fahrenheit unit switching.

3.3 Custom Unit Settings

The display area displays 3.COE, short press the Enter button to enter the custom unit settings. User-defined unit coefficients can be modified by commands, and can also support select inH2O(20°C), inH2O(60°F), mmH2O(20°C), mmH2O(15°C), ftH2O(60°F), ftH2O(4°C) as Custom units. (available only for ADT680A/680AEx/680P/680PEX)

3.4 Date and Time Settings

The display area displays 4.dATE, it includes settings for hour, minute, second, month, day and year. Short press the Enter button to edit. (available only for ADT680A/680AEx/680P/680PEX)

3.5 Pressure Calibration

The display area displays 5.CAL, short press the Enter button to enter the password 1234, and then short press the Enter button again to enter pressure calibration. It includes calibration status display, cancel calibration, and cancel zero. Short press Down button to switch between items.

3.5.1 Calibration Settings

1. Calibration status: When calibration has been performed, CAL-1 will be displayed in the display area, and when it is not calibrated, CAL-0 will be displayed. Short press Enter button to go to calibration process.
2. Cancel calibration: The display shows FAC, short press Enter button to cancel calibration.
3. Cancel zero: The display shows ZERO, short press Enter button to cancel zero.

3.5.2 Calibration Process

There are two situations of calibration.

(1) Single-range instrument: 2-point calibration, the default calibration points are upper and lower limits of the range. The order is to calibrate the lower limit first and then the upper limit. After the upper limit is calibrated, it will return to the calibration status interface.

(2) Dual-range instrument: 3-point calibration, the default calibration points are the lower limit of the range, zero point and the upper limit of the range. The order is to calibrate the lower limit first, then calibrate the zero, and finally calibrate the upper limit. After the upper limit is calibrated, it will return to the calibration status interface.

Now taking the (0~100) kPa instrument as an example to illustrate the calibration process: short press the Enter button under the calibration status menu to enter the calibration process:

1. Display the lower limit calibration point, as shown in Figure 14, the identifier area displays Min to indicate the lower limit of calibration. The display area displays the calibration point being edited, and the focus position will flash. Short press Right button to move the focus position, short press Down button to adjust the value, short press Enter button to confirm the current calibration point and go to lower limit display.



Figure 14 Lower limit calibration point

2. Start lower limit calibration, as shown in Figure 15. The display area shows the measured pressure value, after the pressure stabilized, short press Enter button to confirm.



Figure 15 Lower limit calibration

3. Display the upper limit calibration point, as shown in Figure 16, the identifier area displays Max to indicate the upper limit of calibration. The display area displays the pressure reference value being edited. If the user wants to change calibration point, just change it directly. If not, press the Enter button to confirm.

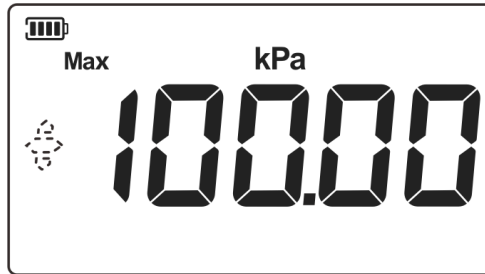

Figure 16 Upper limit calibration point

4. Start upper limit calibration, as shown in Figure 18. After the pressure stabilized, short press Enter button to confirm.



Figure 17 Upper limit calibration

5. Now the calibration is completed, return to calibration status menu and it will show CAL-1, which indicates the calibration takes effect. As shown in Figure 18.

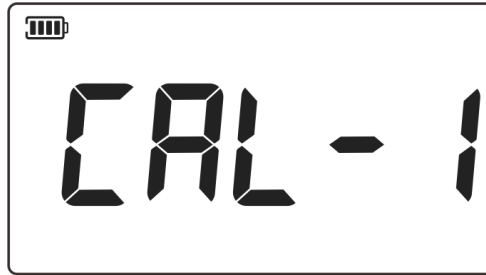

Figure 18 Calibration status menu

3.6 System Settings

3.6.1 Restore to Factory Settings

The display area displays 1.REST, short press Enter button to enter password, the default password is: 1234. Then short press Enter button to restore to factory settings. Short press Power button to go back to previous menu.

3.6.2 Version Information

The display area displays 2.SOFT, and the display area shows the system firmware version.

3.6.3 Over Pressure Records

The display area displays 3.OVER, short press Enter button to view the over pressure records.

3.6.4 Pressure Module Version Information

The display area displays 4.PM, short press Enter button to view the pressure module version. (available only for ADT680P/680PEx)

3.7 Communication Settings

3.7.1 Bluetooth MAC Address

The display area displays 1.MAC, short press Enter button to view the Bluetooth MAC address. Only the last five digits of the MAC address will be displayed.

3.7.2 Bluetooth Auto-off Settings

The display area displays 2.AbLE, short press Enter button to enable or disable the Bluetooth auto-off function. Once it is enabled, Bluetooth will automatically turn off after one hour of disconnection.

3.7.3 Serial Settings

Baud rate settings: The display area displays 3.bAUd, short press Enter button to edit. It supports 4800, 9600, 19200 and 38400, the default baud rate is 9600.

Address settings: The display area displays 4.Add, short press Enter button to edit. It supports 1~112.

3.8 Operation Error Codes

When performing function operations or information editing on the screen, the pressure gauge will prompt in the form of error codes as the screen cannot display detailed text.

Table 7 Operation Error Codes List

Error codes	Description	Solutions
001	Password wrong	Check the password
002	Parameter beyond the range	The entered value is beyond the gauge's



		range, enter a new value
003	Operation execution failed	Try it again

4. Connect to Additel Link App

4.1 Download Additel Link

Additel Link is a mobile app available on Android and iOS system. It can connect to pressure gauges through Bluetooth, display real-time pressure reading and status, configure gauge parameters, switch pressure units, pressure zero, start/stop data log, download and view data from the gauge, calibrate pressure gauges and export CSV data for sharing.



Figure 19 QR code for downloading Additel Link

4.2 Enable the Bluetooth

Check and make sure the Bluetooth of the cell phone is enabled, then go to the gauge and long press Zero button to turn on/off the Bluetooth.

4.3 Connect to the Gauge

4.3.1 Scan the Code

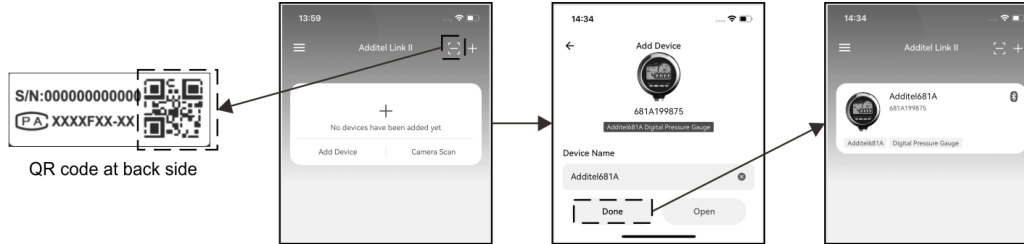

Figure 20 Scan code for connection

4.3.2 Manual Connection by Searching MAC Address

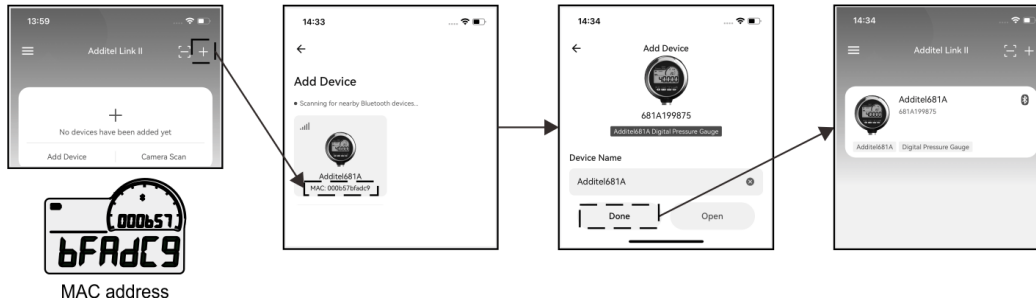

Figure 21 Manual search for connection

5. Copyright

Additel owns all copyrights to this system and reserves all rights. Please respect the rights of our company.

Appendix A: RS232 Module DB9 Pins Description

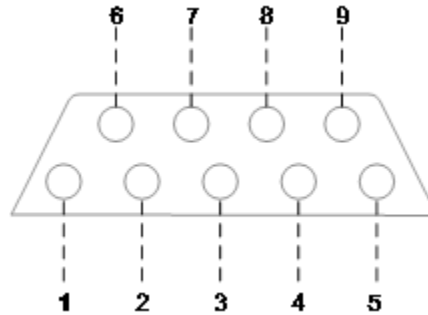

Figure 22 RS232 module DB9 female pins description

Table 8 RS232 Module DB9 Pins Description

Pins	Description
1	Reserved
2	TXD
3	RXD
4	Reserved

5	GND
6	Reserved
7	Reserved
8	Reserved
9	Reserved

Appendix B: Specific Conditions of Use for Additel680AEx/Additel680PEx/Additel601Ex/Additel601PEx

i. The RS232 port shall only be used for data download and power supply when in the non-hazardous area.

Any devices connected to RS232 port shall be approved as SELV or Class 2 equipment against EN/IEC 60950 or an equivalent EN/IEC standard. The port has been assessed with a U_m of 16 Vdc and shall be installed in accordance with clause 16.3 of IEC 60079-14:2013/EN 60079-14:2014.

ii. The equipment shall only be fitted with the following alkaline batteries: Energizer E91, Rayovac 815, Maxell LR6.

Appendix C: ADT680AEx/680PEx/601Ex EX-Proof Description

Conform below intrinsically safe certifications:

IECEX & ATEX:

 II1G

Ex ia IIC T4 Ga

Ta=-20°Cto+50°C

CSANe 23ATEX1219X

IECEX CSA 23.0050X

CSA:

IS CL I, DIV 1, GP A, B, C and D,T4

CL I,ZN 0, AEx ia IIC T4 Ga

Ex ia IIC T4 Ga

Ta=-20°C to +50°C

CSANe 24CA80191482X

Ta=-20°Cto+50°C



Additel Corporation

2900 Saturn Street #B

Brea, CA 92821 USA

Phone: 714-998-6899

Email: service@additel.com

website: www.additel.com